

ITEM NO. CART4426EH-C

44" x 25"
SHELF

2-SHELF SERVICE CART

with **V-CUT** & HD Casters

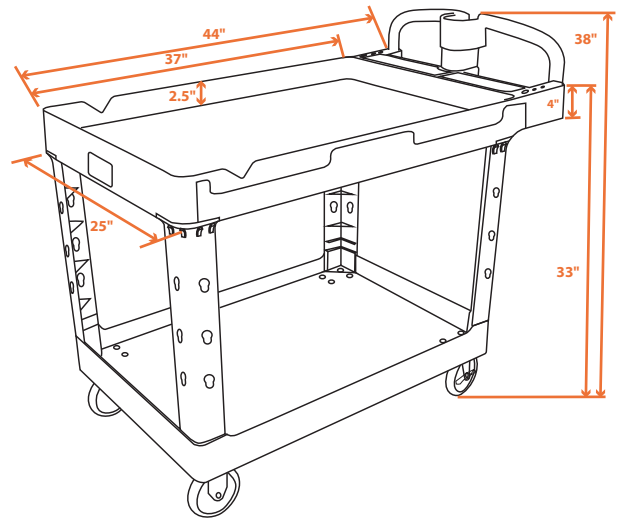

- Cart size: 44"x25"x38", 2.5" deep shelves
- 5" HD non-marking casters (2 fixed and 2 swivel w/ brake)
- V-Cut securely holds materials for accurate measuring or cutting
- Tough polypropylene structural foam construction
- Ergonomic handle for comfort and ease of use

Load Capacity:	500 LB
Item Size:	44"L x 25"W x 38"H
Item Weight:	48 LB
Shelf Depth:	2.5"
Shelf Quantity:	2
UPC:	782156065972