

2-Shelf Utility Cart

ITEM NO. **CART4426E**

44" x 25" SHELF

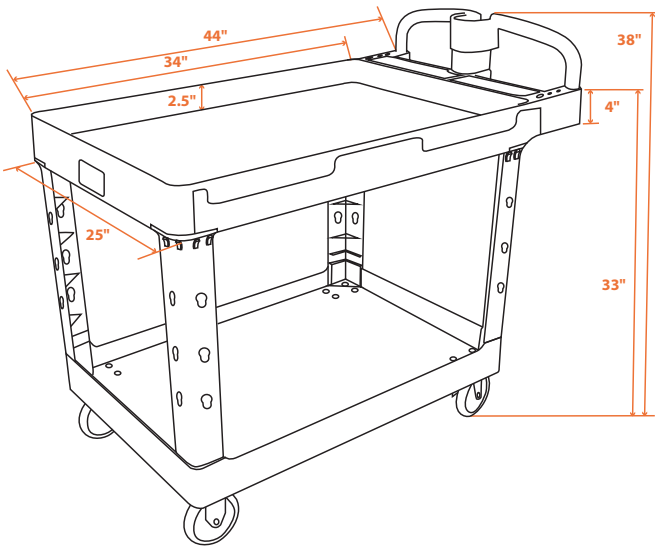

- Cart size: 44"x25"x38", 2.5" deep shelves
- Load capacity: 500 LB
- 5" non-marking casters (2 fixed and 2 swivel)
- Tough polypropylene structural foam construction
- Ergonomic handle for comfort and ease of use

Load Capacity:	500 LB
Item Size:	44"L x 25"W x 38"H
Item Weight:	46 LB
Shelf Depth:	2.5"
Shelf Quantity:	2
UPC:	782156002892